

garden





105 | 130 | 150

STOCKER-CREW

A trading division of ALVECO PTY.LTD. (ABN: 40 074 146 535)
 Postal Address: PO Box 203, Warners Bay, NSW 2282
 Telephone: (02) 4954 8900 Fax: (02) 4954 8902
alveco@ceinternet.com.au



USE: Flail Mower for mini-tractors. Suitable for greens, gardens, parks, etc.

MODEL	A cm	B cm	C cm	D cm	E cm	 max Ø 1.5 cm		 Kg	 min - max
GARDEN 105	120	30	61	85	108	48	2	130	12 - 25
GARDEN 130	144	30	61	85	132	64	3	170	18 - 25
GARDEN 150	166	30	61	85	155	80	3	190	22 - 25

• STANDARD EQUIPMENT

- PTO 540 RPM
- 3 POINT LINKAGE CAT. I
- SKIDS
- REAR ROLLER
- FREE WHEEL IN THE GEARBOX

GARDEN 150

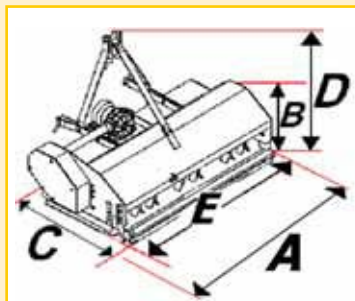

GARDEN 105





GARDEN 130



ROLLER

OPTIONAL:
 ROTOR WITH LIGHT HAMMER

OPTIONAL:
 MECHANICAL SIDE SHIFT

OPTIONAL:
 HYDR. SIDE SHIFT